

C-MOS MICRO-PROCESSOR CONTROLLED

DIGITAL PHASE LOCKED SYNTHESIZER

2m VHF FM TRANSCEIVER



MODEL FM-2033

INSTRUCTION MANUAL



KYOKUTO DENSHI CO., LTD.
21-25, 6 chome, Honcho, Nakano-ku, Tokyo 164, Japan

GENERAL FEATURES.....	(1)
OPERATING CONTROLS AND INSTALLATION	
2.1 Operating Controls and functions ...	(2)
2.2 Memory Channel Relationships.....	(4)
2.3 Mobile Installation.....	(5)
2.4 Fixed Installation.....	(5)
BLOCK DIAGRAM.....	(6)
PHOTOGRAPHS OF TRANSCEIVER INTERIOR.....	(7)
CIRCUIT DESCRIPTION	
5.1 Receiver	(8)
5.2 Transmitter	(8)
5.3 PLL	(8)
5.4 CPU Control Section	(9)
TABLE (1) CPU program initialization ...	(9)
TABLE (2) CPU data output	(9)
TABLE (3) CPU commands	(10)
ALIGNMENT:	
6.1 PLL unit	(11)
6.2 Receiver	(11)
6.3 Transmitter	(11)
OTHER MISCELLANEOUS INFORMATION	
7.1 Manual tone operation	(12)
7.2 Changing VFO to "wrap-around" mode	(12)
7.3 Memory back-up battery	(12)
7.4 TM-2, DM-100 circuit diagrams.....	(12)
7.5 Delayed scan resume	(12)
SPECIFICATIONS, FM-2033	(13)



1. GENERAL FEATURES

The FM-2033 continues the KDK tradition of obtaining maximum operating features while retaining ease of operation, all in a small front panel and overall package size. The KDK design team achieved this by calling on their many years of experience in designing compact, VHF, mobile transceivers. The maximum use of multi-functional controls with co-axial knobs rather than a profusion of push buttons, and, in-house developed microprocessor programming provides a unique control system stressing "eyes-on-the-road" operations to enhance driving safety.

NOTE: This manual is written for the (A) version of the FM-2033. Where information differs for the (E) version sold in most European countries, information is added following an asterisk "*".

1. USER PROGRAMMABLE FUNCTIONS

Basic operating parameters can be re-set by the user by changing diodes located on a compact, plug-in, INITIALIZATION module. These are:

- a. Dialing steps, 2.5 - 40KHz. Set at factory to 5KHz, *12.5KHz. (In multiples of 2.5KHz.)
- b. Low frequency band edge (LPBE). Lowest frequency for transmit and receive. Can be set 142.00 - 155.00MHz. Set at factory to 142.00MHz, *144.00MHz.
- c. Transmit high frequency band edge (THFBE). Highest transmit frequency. NOTE: Actual highest frequency is one step below limit set by THFBE matrix. Can be set 142.00 - 155.00MHz. Set at factory to 150.00MHz, *146.00MHz.
- d. Receive high frequency band edge (HFBE). Can be set 142.00 - 155.00MHz. Set at factory to 150.00MHz, *146.00MHz.
- e. Offset frequency (for \pm offset mode). 100KHz - 1.6MHz. In-multiples of 100KHz. Set at factory to 600KHz.
- f. Programmable DIAL EDGE mode. Dial operation mode at LFBE and HFBE can be set for "wrap-around" or "non-wrap" mode. Set at factory to "non-wrap" mode.

2. SPEED BUTTON

Speeds up dialing rate to 100KHz for rapid dialing to a widely separated frequency.

3. RIT (Receiver incremental tuning)

A digital RIT to shift receiver only in 1KHz steps. Max shift \pm 1 dialing step. Operates in all modes; VFO, MEMORY and CALL.

4. REVERSE BUTTON (DIAL KNOB)

Push on dial knob to monitor duplex transmit channels. Operates in \pm offset and AxB duplex

modes. Also, RIT.

5. PROGRAMMABLE BAND SCANNING

Band scanning limits are frequencies written in to memory channels #5 and #10. Any portion or all of total frequency coverage can be selected. Set at factory to 144.500 and 148.500MHz, *145.500MHz.

6. TWO MODE SCANNING

Scanning in busy and open modes permits maintaining watch on busy channels as well as searching for vacant channels.

7. ELEVEN MEMORY CHANNELS

CALL memory plus 10 memory channels. Memory channels in two groups A and B. Groups A and B may be scanned separately or in total as set by memory mode switch. In AxB mode memory channels 1 - 5 are set for receiving and transmitting on corresponding channel 6 - 10. Permits memory of 5 non-standard offset frequency pairs.

MEMORY information includes transmit offset +, - or simplex as set by memory mode switch.

8. INTERNAL MEMORY BACK UP NICAD BATTERY

All memory channels and dial frequency data retained by internal back-up NICAD battery. The battery is automatically charged during operation of transceiver. Memory contents are retained even if the transceiver is disconnected from power source.

9. LCD FIVE DIGIT DISPLAY

Front panel LCD display for good visibility in bright sunlight. Five digit display for indication down to 100Hz digit providing full read-out of 12.5KHz channel spacing frequencies.

10. TWO MODES OF MEMORY CHANNEL INDICATION

Memory channel number, or frequency, as selected by function switch.

11. CALL CHANNEL

Extra memory for storing frequently used frequencies. Instant recall by a flick of function switch. Stored frequency can be changed by dialing up new frequency, setting function switch to CALL, and pushing WRITE switch.

12. INTERNAL PLUG IN TONE OSCILLATOR

Switched on by pushing TONE button. 2033A - CTCSS encoder (Tunable, set at 103.5Hz ex-factory.) 2033E - 1750Hz crystal controlled tone burst. Can be set to provide manual controlled continuous tone. (See 7.1, page 12.

2. OPERATING CONTROLS AND INSTALLATION

2.1 OPERATING CONTROLS AND FUNCTIONS

This section describes functions of various knobs, switches, indicators and connectors on front and rear panels of the FM-2033. Photographs of panels are numbered identically with the paragraphs.

(1) FUNCTION SWITCH

Switches function of DIAL, (2).

VFO Dial knob (2) selects frequency. (Dialing)
M-CH Dial knob selects memories. Display (4) shows memory numbers.
M-FR Dial knob selects memories. Display shows memory frequencies.
CALL Call channel selected and dial disengaged.

Electronic alarm beeps at lowest and highest frequency, lowest and highest memories, also upon reaching channel edge for RIT.

(2) DIAL KNOB (AND REVERSE SWITCH)

Knob dials frequencies or memories as selected by FUNCTION switch (1) and RIT button:

- In 5KHz steps, *12.5KHz
- In 100KHz steps when SPEED, (17), engaged.
- 1KHz steps, receiver only, when RIT, (16), engaged.

REV switch when pushed. Reverses receive and transmit frequencies for offset and RIT (for both the ± offset and AxB offset modes.)

(3) SCAN SWITCH

BUSY: Scanning starts. Stops upon reaching channel in use. Resumes soon as channel clears. To resume scanning while signal continues, step up one channel using dial knob or microphone UP button.

HOLD: Center, scanning "off" position for manual control.

OPEN: Scan starts. Stops upon reaching vacant channel. Resumes as soon as signal appears on channel. To resume scanning while channel continues vacant, step up one channel using dial knob or microphone UP button.

NOTE: In units supplied to certain countries, a 3 second delay has been built in to SCAN RESUME. In such units, the OPEN scan feature is inoperative. (See paragraph 7.5, page 12)

Type of scan set by FUNCTION SWITCH, (1), as follows:

VFO: Band scan. Scan limits are frequencies set in memories 5 and 10. Scans between these two freq. Band scan increments are same as dialing steps.

M-CH: Memory scan. DISPLAY (4), shows memory no.

M-FR: Memory scan. DISPLAY (4), shows memory freq.

SCAN SKIP: In memory scanning, unwanted channels

may be skipped to speed up scan repetition rate. Store lower band edge frequency in memory to be skipped. For example 142.000, *144.000.

(4) DISPLAY LCD

Shows frequencies in five digits in DIAL, M-FR and CALL positions of FUNCTION switch (1). Shows memory number in M-CH position. (Changes to show frequency when a new frequency is written in to memory and returns to memory number as soon as WRITE button is released.)

(5) RECEIVE LED

Lights up while signal being received. (Receiver unscelched.)

(6) TRANSMIT LED

Lights up during transmitting. (Lights up at band edges but transmitter inoperative to prevent an out-of-band transmission.)

(7) SIGNAL/POWER INDICATOR

Dual function bar type LED meter to show relative strength of incoming signal AND transmitter output.

(8) MICROPHONE CONNECTOR

Connector for microphone. Includes 13.8 volt power source for KDK TM-2 tone encoder microphone. (DM-100 UP/DOWN microphone provided in some countries, in which case the TM-2 may be optionally available from distributor or dealer.)

(9) HIGH LOW BUTTON

Selects transmitter output power. HIGH, 25 watts; LOW, 5 watts. Both can be reset for intermediate values. Do not set at less than 5 watts.

(10) TONE BUTTON

Selects tone for repeater use. Type of tone operation set by plug-in module. TONE-2033A: CTCSS - frequency varied by internal trim-pot. TONE-2033E: crystal controlled 1750HZ tone burst. (See page 12 for manual tone control.)

(11) SQUELCH CONTROL

Mutes receiver noises during no signal conditions. Should be set at point where noise is just squelched out when advanced in a CW direction from extreme CCW position.

(12) OFFSET SWITCH

- S Simplex. Transmit and receive on same freq.
- + Transmit 600KHz above receive frequency.

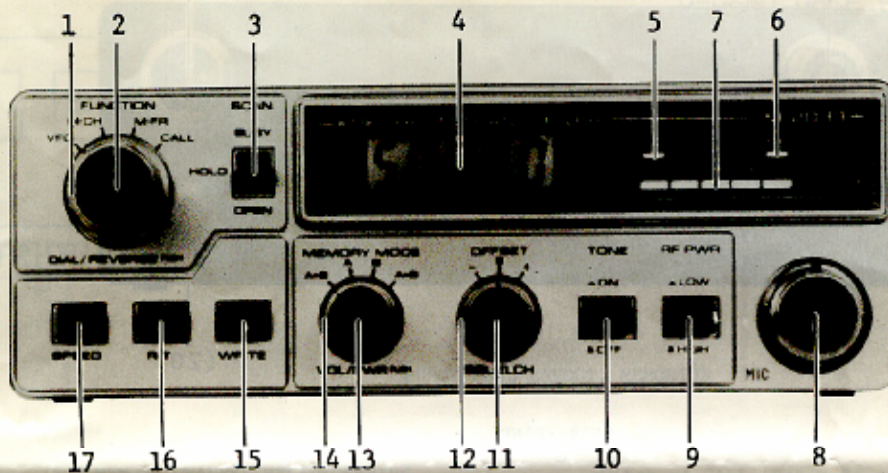

FRONT PANEL

- Transmit 500KHz below receive frequency.

DISPLAY (4), switches between receive and transmit frequency. Amount of offset re-programmable by changing diodes in INT-2033 module. If offset exceeds upper or lower band limits, display shows ---- as soon as P/T is keyed and cannot transmit.

(13) VOLUME/POWER CONTROL.

Volume increases as knob turned in a CW direction.
Push knob to turn power on. Push again to turn off.

(14) MEMORY MODE SWITCH

A+B Selects all memories, 1 through 10.
A Selects memories 1 through 5
B Selects memories 6 through 10
AxB Duplex using memories. Receive on memories 1 through 5 and transmit on corresponding 6 through 10. DISPLAY (4), switches between receive and transmit frequencies.

(15) WRITE BUTTON:

Push to write desired frequency to CALL and memory channels.

PRIORITY WRITE-IN: Pushing this button while in VFO mode of function switch, will write dialed frequency in to memory #1. Suggest memory #1 be

used for storage of frequencies to be used only temporarily.

(16) RIT (Receiver Incremental Tuning)

When engaged, DIAL (2) and UP/DOWN buttons (22) (23), shifts receiver in 1KHz steps. Operates in DIAL, M-FR and CALL functions. Maximum shift \pm one dial step.

NOTE 1: When RIT engaged, RIT may be cleared and receiver returned to center by switching FUNCTION switch (1) to other position momentarily, then returning to original position.

NOTE 2: RIT must be disengaged in order to DIAL or select memories.

(17) SPEED SWITCH

Increases dialing rate to 100KHz per step. Use for rapid dialing to a widely separated frequency. (This function inoperative during band scanning.)

(18) ANTENNA CONNECTOR

SO-239 type. Will accept both metric and inch threaded plugs.

(19) DC CONNECTOR

Receptacle for connecting DC 13.8 volts. Use cable supplied with transceiver. Connect red lead to positive and black lead to negative terminal. Use only 7A fuses.

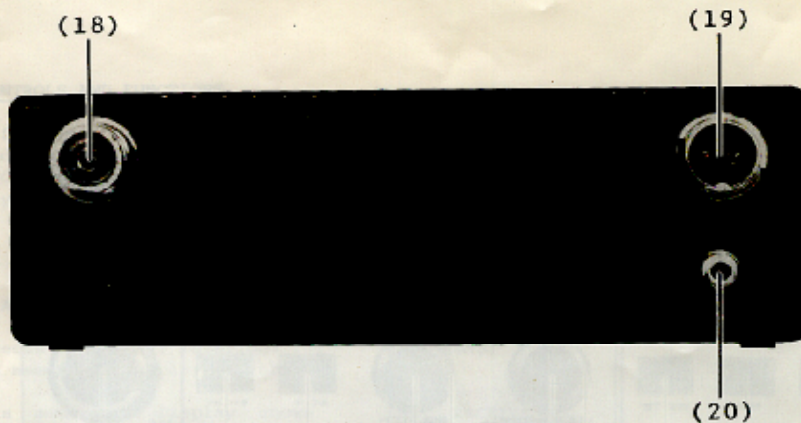

REAR PANEL

(20) EXTERNAL SPEAKER JACK

A mini plug to fit this jack is included as a standard accessory.

(21) P/T (Press to talk) SWITCH

Press to key transmitter.

(22) DOWN BUTTON

A momentary push will:

- a. VFO: Lower frequency by one step.
- b. M-CH: Select next lower memory. Also M-PR.
- c. RIT: Lower frequency by 1KHz.

If button is held down, above action repeats, slowly at first and then faster, until button is released or maximum RIT shift is reached.

(23) UP BUTTON

Same action as down button except direction of change is upwards.

(24) TO NE ENCODER BUTTONS

These buttons transmit standard telephone dialing tones. Frequencies are as shown below. Pushing buttons, keys transmitter and not necessary to hold down P/T switch, (20). Transmitter continues to be keyed for about .7 seconds after button released, permitting smooth key-in of a sequence of numbers.

	LOW TONES	HIGH TONES	
	1209	1336	1447Hz
697	1	2	3
770	4	5	6
852	7	8	9
941	#	0	*

NOTE: Where DM-100 is standard microphone provided with the transceiver, the TM-2 may be optionally available from distributor or dealer.

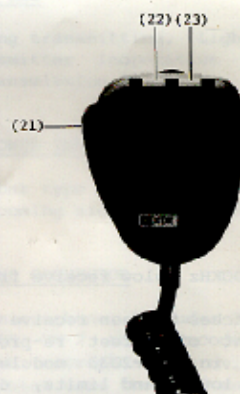

DM-100 MICROPHONE

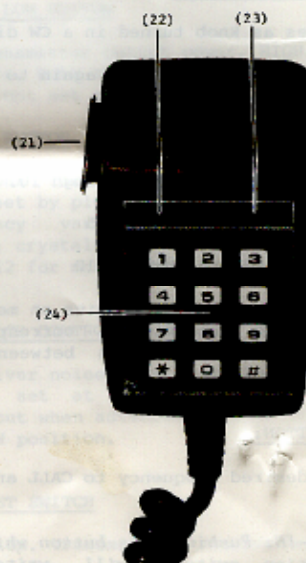

TM-2 TONE ENCODER MICROPHONE

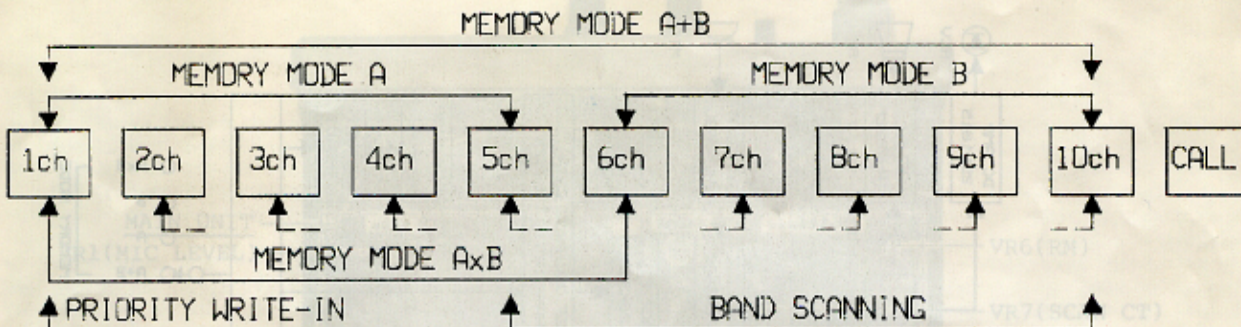

FUNCTIONAL LAYOUT, MEMORIES

2.2 MEMORY CHANNEL RELATIONSHIPS

(1) CALL CHANNEL

Dial desired frequency. Set FUNCTION switch to CALL. Push WRITE button.

(2) MEMORY CHANNELS

Dial desired frequency. Set FUNCTION switch to M-CH and select desired memory. Push WRITE button. DISPLAY will change to selected frequency signifying the frequency has been written in. As soon as write button is released, display will return to showing memory channel number.

(3) BAND SCAN LIMITS

Desired upper and lower limits for band scanning should be written in to memories #5 and 10. NOTE: When designating the highest frequency as the upper limit, use frequency 1 step down from the HFBE, i.e., if HFBE=149.000 then use 148.995MHz, *145.9675MHz.

(4) SCAN SKIP, MEMORY SCANNING

Reducing number of channels scanned increases relative speed of scanning. Thus scanning in the A or B mode is twice as fast as scanning in the A+B mode. Speed can be further increased by removing unnecessary channels from scanning sequence. This is accomplished by writing in the LFBE frequency to the unwanted memory, i.e., 142.000, *144.000MHz.

(5) ENTERING OFFSET MODE TO MEMORIES

Select desired frequency in VFO mode. Set FUNCTION switch to M-CH and select desired memory channel. Set mode switch to Simplex, + or - as desired. Push WRITE switch.

(6) ENTERING OFFSET MODE TO CALL MEMORY

Select desired frequency in VFO mode. Set FUNCTION

switch to CALL. Set mode switch to Simplex, + or - as desired. Push WRITE switch.

2.3 MOBILE INSTALLATION

(1) Install mounting bracket included with unit under dashboard or convenient location using four, 4 x 12mm, self tapping screws located in small plastic bag in microphone carton. A 3mm hole should be pre-drilled to use these self tapping screws.

(2) Mount the transceiver in bracket using two black thumbscrews provided. Select best angle of installation for easy operation. The bracket, while very simple in design, is very flexible to match various mounting situations.

(3) Connect antenna feed cable to connector on rear panel. The SO-239 type connector will accept both metric or inch threaded plugs.

(4) Connect red/black cable packed in microphone carton to power source. Red lead is + and black - (negative ground). These should be connected to point with lowest possible impedance such as directly to the battery, or as a 2nd choice, the fuse box.

(5) Plug mike into connector, (8) on front panel.

2.4 FIXED INSTALLATION

(1) Rubber feet are provided on the bottom of unit. It is frequently easier to operate if the unit is placed so front panel is tilted upwards. An extra mobile bracket can be used for this as shown in the cover photograph.

(2) A good battery or regulated power supply of sufficient capacity should be used. A power supply of insufficient capacity may result in damaging the transceiver.

(3) For other information, refer to paragraphs 3, 4 and 5 of the preceding section.

4. INTERNAL VIEWS

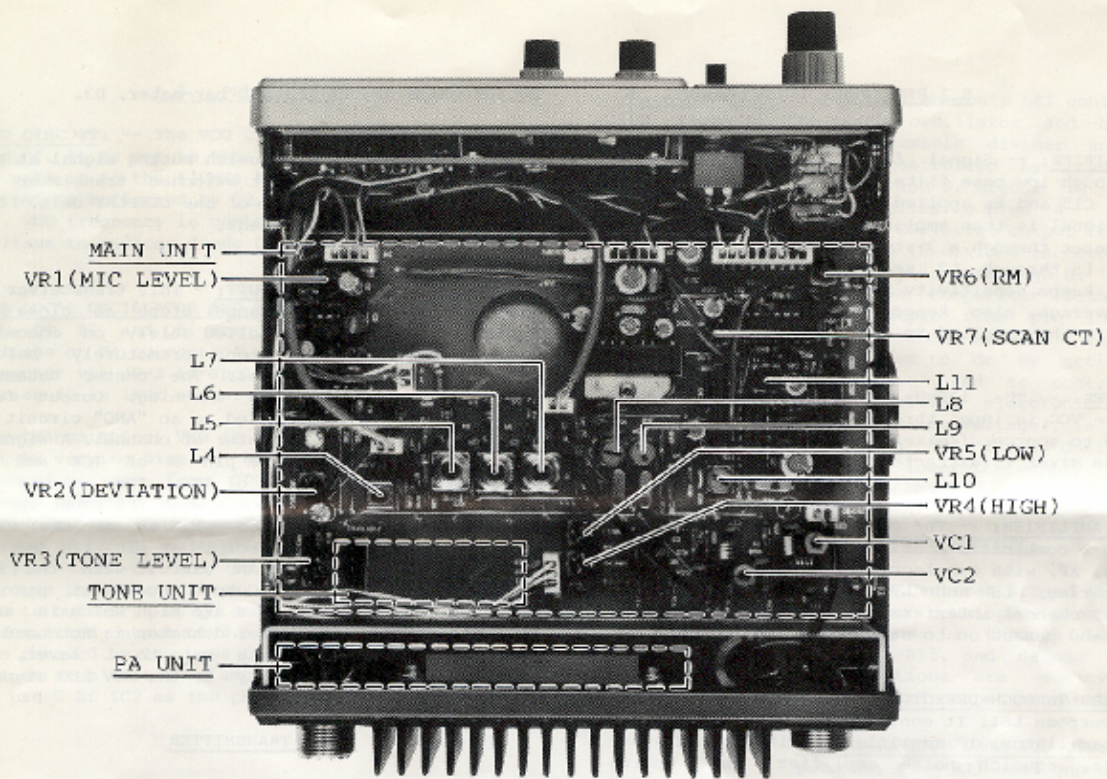

TOP VIEW SHOWING MAIN UNIT WITH 2033A TONE MODULE

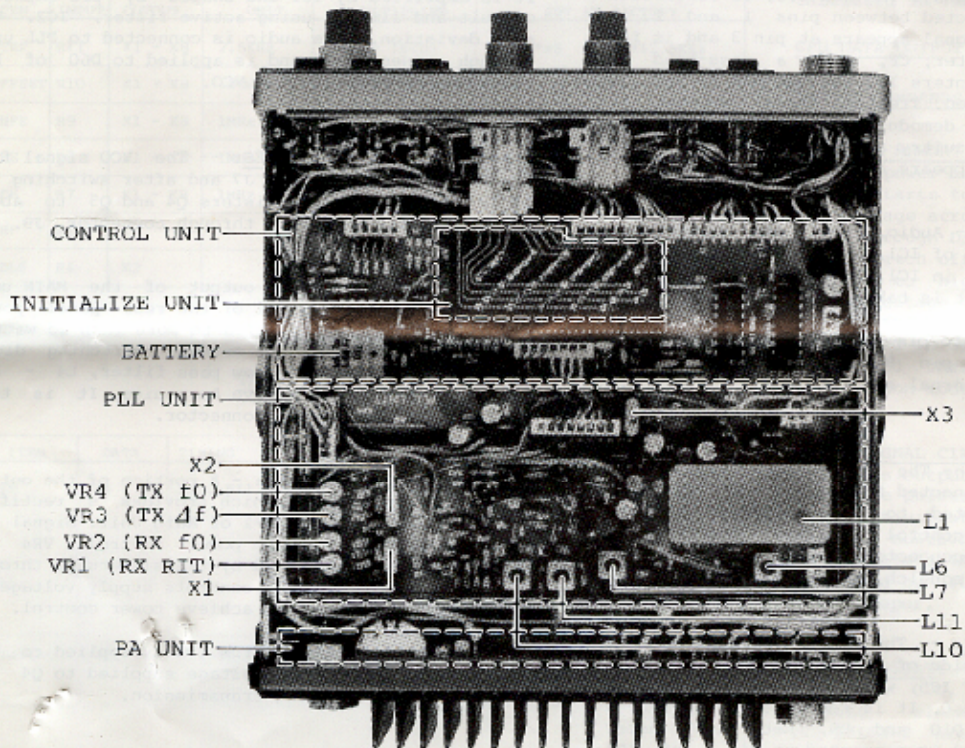

BOTTOM VIEW SHOWING PLL AND CONTROL UNITS

5. CIRCUIT DESCRIPTION

5.1 RECEIVER

RF AMPLIFIER: -- Signal from antenna connector is fed through low pass filter, L6, L5, L4, C20, C17, C16 and C15 and is applied to connector J5 of MAIN unit. Signal is then amplified by MOS-FET Q6. It then passes through a 3-stage electronic auto tuned circuit L5 through L7 and D4 through D6. This circuit keeps sensitivity constant over the wide band coverage, also keeps out unwanted signals. Signal is then applied to gate of Q2.

1ST MIXER: -- The 130MHz band injection voltage from the VCO is input through connector J7 and is applied to source of mixer, Q7. The 10.7MHz output from the mixer is extracted from drain of Q7.

1ST IF AMPLIFIER: -- The converted signal is passed through a combination of two monolithic crystal filters, XF, with a selectivity of $\pm 15\text{KHz}/3\text{dB}$, and LC filtering, L8 and L9, to further attenuate adjacent channel interference. It is then amplified by Q8, and passed on to next stage, IC4.

2ND MIXER THROUGH DETECTOR: -- IC4 is a one chip multi-purpose LSI. It contains the 2nd mixer, 2nd local oscillator, IF amplifier, limiter, quadrature detector, squelch noise amplifier and muting circuitry. Very few external components are needed improving reliability. The 1st IF signal inputs to IC3 from pin 1b and is mixed in the IC with the 2nd local oscillator signal. The 2nd L.O. is controlled by crystal X, connected between pins 1 and 2. A converted 455KHz signal appears at pin 3 and is fed through ceramic filter, CF, with a pass-band of $\pm 6\text{KHz}/3\text{dB}$. It re-enters IC3 through pin 5 and is amplified and limited. Treated signal appears at pins 7 and 8 and is demodulated by the combination of internal LSI circuitry and quadrature coil, L9. Demodulated audio appears at pin 9 of IC4.

AUDIO AMPLIFIER: -- Audio, from pin 9 of IC4, is applied to pin 7 of IC1, and passes through the de-emphasis circuit in IC1. It re-appears at pin 8 of IC1 from where it is taken to front panel volume control. It is set to proper level by the control and then connected to pin 4 of IC7. Output from IC2 is taken from pin 9 and connected to the speaker via the external speaker jack.

SQUELCH CIRCUITRY: -- The demodulated signal from pin 9 of IC4 is connected to pin 7 of IC3 from where it is connected to the internal low-pass filter and squelch control circuitry. Front panel squelch control is connected to pins 1 and 4 of IC3 and is used to set squelch threshold levels.

"S" METER CIRCUITRY: -- The signal for the meter is taken from output side of ceramic filter, CF, and applied to pin 1 of IC5, where it is amplified and then output from pin 5. It is rectified in a voltage doubler circuit, D10 and D9, set for meter sensitivity by VR6 and is connected to pin 3 of IC1 of the DISPLAY unit. This signal is A/D converted

by IC3 which drives the LED bar-meter, D3.

RCV LED CIRCUIT: -- The squelch muting signal at pin 13 of IC4 of the main unit switches transistor Q9 to drive the RCV LED, D1, of the DISPLAY unit. LED lights up when squelch opens.

SCAN CENTER DETECTOR CIRCUIT: -- This transceiver is designed to operate on channel steps as close as 2.5KHz. If SCAN control relied solely on incoming signal, scanning may stop prematurely before reaching center of channel. The center detector prevents this in busy mode scanning. Output from detector and RCV LED are fed to an "AND" circuit so scanning halts only at center of channel. A signal, (4V $\pm 1\text{V}$), is obtained from pin 9 of IC4 and is connected to pins 1 and 2 of IC6. IC6 outputs an inverted signal at pin 3 only when its input is 4V $\pm 1\text{V}$. This is connected to pin 13 of the BUSY control. Output from control is at pin 11 and is connected to pin 9 in an AND circuit with the RCV signal applied to pin 8. Output appears at pin 10 only when both pins 9 and 8 are high which is used to control scanning. Center detector is not used in OPEN scanning. Pin 12 is set to L level, so scanning is controlled only by the RCV LED signal.

5.2 TRANSMITTER

MICROPHONE AMPLIFIER: -- Audio signals from the mike are adjusted for level by control VR1 on MAIN unit. It is amplified by IC1 and shaped by pre-emphasis circuit and limiter using active filter, IC2. VR2 sets deviation. This audio is connected to PLL unit through connector J6 and is applied to D60 of PLL to frequency modulate the VCO.

TRANSMITTER EXCITER STAGES: -- The VCO signal from the PLL is input through J7 and after switching by D7 is amplified by transistors Q4 and Q5 to about .5 watts. This is output through connector, J9.

POWER AMPLIFIER: -- The output of the MAIN unit from J9 is applied to IC1 of the rear panel power amplifier unit and amplified to more than 25 watts. Its output passes through antenna switching diode D1 and then through the low pass filter, L4 - L6, C15 - C17 and C20 to remove harmonics. It is then connected to the antenna connector.

APC (AUTO POWER CONTROL): -- A portion of the output is sampled by diode D4 which provides a rectified output from pin 10 to J8-1 of Main Unit. Signal is fed through the Hi and Lo power controls VR4 and VR5 and is then amplified by transistors Q1 through Q3. The amplified output controls supply voltage to transistors Q4 and Q5 to achieve power control.

Transmitter stop signal from CPU is applied to APC through J8-3 and lowers voltage supplied to Q4 and Q5 effectively stopping transmission.

5.3 PLL SECTION

VCO CIRCUIT: -- The VCO circuit is formed by L1, D1 and Q1. It is set to the 130MHz band for receiving, D2 sets it to the 140MHz band for transmitting. VCO output is buffered by Q2, Q3, and is output from J1. VCO frequency is controlled by applying a DC voltage to varicap diode D1 locking VCO in to PLL.

PLL LOCAL OSCILLATOR AND MIXER: -- PLL L.O. is a VXO, D4, X2, and Q5. Frequency is set by varying voltage on D4 by control, VR4. RIT voltage from computer via J9-3 is applied to D4 through VR3 and varies FO in 1KHz steps.

For transmitting, VXO is X1, D3, Q5. Frequency is set by varying bias on D3 by VR2. A fine tune control voltage from CPU (for 2.5KHz and 5KHz steps) via J9-3 is set by VR1 and applied to D3 to fine tune the local oscillator.

Output of Q5 is multiplied by 9 using Schottky barrier diode D7 and is applied to mixer, Q6, through band-pass filter, L10 and L11. Output from VCO is buffered by Q4 and applied to Q6 to obtain a converted output of 3.67 - 9.67. Unwanted spurs are removed by low-pass filter L12, C30 and C31. Output from filter is amplified by IC1 and applied to pin 9 of IC2 as the phase comparator signal.

PLL CIRCUITRY: -- IC2 is a one-chip LSI containing the standard frequency oscillator and divider, phase comparator, programmable divider and data latch. The standard is controlled by crystal X3 connected between pins 2 and 3. Signal is divided by 900 as set by data applied to pins 4 - 8. Lo obtain a 10KHz standard. Converted output from pin 6 is applied to pin 9 and is divided according to data from CPU applied to pins 4 through 8. Divided signal is fed to phase comparator with 10KHz standard. A pulse is output from pin 15 which relates to phase difference between the two signals. Pulse is converted to dc by active low pass filter Q8, Q9, and is used to control VCO frequency as well as receiver electronic tuning circuits. V voltage, TV (Tuning Voltage), is output via TP3. Pin 13 outputs an "H" level during PLL unlock and switches Q7 to lower the supply voltage on Q3 to stop output from the VCO.

5.4 CPU CONTROL SECTION

All control functions are centered around the CPU, MP-5366, with KDK in-house developed programming. Data inputs are K1 - K8 and L1 through L8. Time division outputs are R0 - R15, and decode outputs 00 - 07. Control functions are achieved by connecting various input and output terminals.

INITIALIZATION DATA FOR CPU: - Outputs R4, R7 - R11 are connected to input K1 - K8 by BCD coded diode matrixes on initialize module to command various actions to CPU as tabulated in Table (1).

CPU DATA OUTPUT: -- See Table (2).

IN/OUT COMMANDS: - See Table (3).

INTERNAL MEMORY BACKUP NICAD: - As soon as power is switched off, 5V supply starts to drop. Q2 is cutoff and voltage across R12 is connected to K8 through D5 to advise CPU of power switch off. CPU switches all outputs to high impedance. As supply voltage drops, Q1 is cutoff and CPU HLT terminal switches to H level. CPU is backed-up by internal NICAD and changes to low power consumption mode.

TABLE (1) PROGRAM INITIALIZATION

ITEM	INPUT	OUTPUT	UNIT	MULTIPLIER	SET AT FACTORY
STEP	R11	K1 - K8	2.5KHz	x1 - 16(0)	x2, *x5 5, *12.5KHz
OFFSET	R10	K1 - K8	100KHz	x1 - 16(0)	x6 600KHz
TIME	R9	K1 - K8	1MHz	x1 - 16(0)	x9, *x6 150, *14MHz
HFE	R8	K1 - K8	1MHz	x1 - 16(0)	x9, *x6 150, *14MHz
LFE	R7	K1 - K8	1MHz	x1 - 16(0)	x3, *x4 142, *14MHz
UNF	R4	K4	-	Offset base frequency changed to 500KHz	
EDLS	R4	K2	-	Commands "wrap-around" dial mode	

* 2030 (E)

TABLE (2) DATA OUTPUT

ITEM	DATA	TIMING	ACTION
RIT	04 - 07	R10, R11	IC4 (04 - 07) outputs RIT data (BCD) and IC4 (R10, R11) outputs latching pulse. Resistor matrix of IC4 (2x 4bit latch) D/A converts to output RIT voltage to the PLL.
PLL	04 - 07	R15	IC4 (04 - 07) outputs PLL data (BCD) and IC4 (R15) outputs latching pulse to set dividing ratio of programmable divider.
DISPLAY	00 - 03	R7, R8	IC4 (00 - 03) outputs display data (BCD) to LCD driver. IC4 (R7, R8) is connected to LCD driver CE and STD which reads and latches data.

ALARM SIGNAL CIRCUIT: -- The alarm signal is output from CPU terminal R6. These pulses are widened by one shot multivibrator IC3-3, IC3-4 and switches multivibrator IC3-1, IC3-2 to generate a 4KHz signal. This is buffered by IC2-3 to drive the alarm beeper.

LCD CIRCUITRY: - 4bit parallel data from the CPU, STD, CE and the framing clock signals from IC2-1/IC2-2 are applied to LCD driver, TP0401 to dynamically drive the 5 digit LCD, LD-200.

TABLE (3) OTHER CPU COMMANDS

ITEM	OUT/IN	DETAILS OF COMMAND
VFO, FUNC sw.	RO - NC	Commands VFO mode for dialing.
M-CH, "	RO - K1	Commands memory dialing with memory number display
M-FR, "	RO - K2	Commands memory dialing with frequency displayed
CALL, "	RO - K4	Commands CALL memory operation
A+B, MEMO sw.	R1 - K2	Selects memories 1 through 10
A, "	R1 - NC	Selects memories 1 through 5
B, "	R1 - K1	Selects memories 6 through 10
AxB, "	R1 - K4	Receive on memories 1 - 5, transmit 6 - 10
OPEN, SCAN sw.	R2 - K1	Directs OPEN mode scanning
HOLD, "	R2 - NC	Directs scanning to stop and hold (Scan off)
BUSY, "	R2 - K2	Directs BUSY mode scanning
+ , OFFSET sw.	R2 - K4	Directs 600KHz plus transmit offset
S, "	R2 - NC	Directs transmit on same frequency as receive
- , "	R2 - K8	Directs 600KHz minus transmit offset
WRITE, WR sw.	R3 - K4	Directs "write in" to memories and CALL channels
SPEED, SPD sw.	R3 - K4	Sets dial to 100KHz steps
RIT, RIT sw.	R3 - K8	Change dial to 1KHz steps, max. ±1 channel width.
REV, REV sw.	R3 - K2	Receive on transmit frequency.
TSTOP ALARM signal	R5 - APC R5 - ALARM	Output whenever transmit frequency exceeds THFBE Output when frequency and memory reaches bottom and top frequencies.
SCN, scan sig.	R12 - SCN	Directs scan START and STOP.
TS, TX signal	R12 - K4	Advises CPU, "transmitting."
DIAL(UP)	R13 - K1	UP signal for dialing frequency or memory
DIAL(DOWN)	R13 - K2	DOWN signal for dialing frequency or memory
MIC(UP)	R13 - K4	UP signal from mike for dialing frequency or memory
MIC(DOWN)	R13 - K8	DOWN signal from mike for dialing frequency or memory

NC = no connection

CAUTION: These alignment instructions are for use by qualified engineers and technicians with access to precision test instruments, including a spectrum analyzer. Attempts by unqualified persons to service the unit may result in serious damage to the unit as well as voiding a warranty policy.

6.1 PLL UNIT

A. **PLL LOCAL OSCILLATOR:** - Connect spectrum analyzer to base of Q6. Adjust L10, L11 for peak output (f=128.63MHz)

B. **VCO LOCK:** - (Set dial to 143.000MHz) Connect spectrum analyzer to TP1 (f=132.300MHz). Connect VTVM to TP3, adjust L1 to obtain a reading of 1.3 volt. Adjust L6 for max on spectrum analyzer.

C. **PLL INPUT:** - Connect oscilloscope to TP2.
a. RX - Adjust L7, L10 and L11 for max. IV/P-P minimum.
b. TX - Transmit. Adjust VR5 for maximum. (1V/P-P min.)

D. **CALIBRATE FREQUENCY:** - (Set dial to 144.000, connect frequency counter to TP1.)
a. RX - Adjust VR4 so counter reads 133.300.
b. TX - Transmit. Adjust VR2 for 133.30.

E. **2.5KHz CALIBRATION:** - (Necessary only if transceiver operated with other than 10KHz steps such as 5KHz, 12.5KHz, 15KHz, etc.) Set dial to 143.005, *144.0125 as per dial stepping, connect counter to TP1, transmit and adjust VR1 so counter reads 143.005, *144.0125.

F. **RIT CALIBRATION:** - (Connect frequency counter to TP1). Set dial to 144.009. Adjust VR3 so counter reads 133.309.

G. **CONFIRM FREQUENCY STANDARD CALIBRATION:** - Connect frequency counter to TP1. Set transceiver to low and top limit frequencies, transmit and confirm frequency is within 200Hz. If frequency is out of limit at top frequency adjust values of C45, C46 of 9MHz oscillator.

6.2 RECEIVER

A. **2ND LOCAL OSCILLATOR:** - Connect frequency counter to pin 2 of IC-1(TK10420) taking care not to load down circuit. Confirm frequency within 200Hz of 10.245MHz.

B. **RF AMPLIFIER:** - Connect 146.000MHz signal to antenna connector. Set transceiver to 146.000MHz. Connect VTVM to TP and adjust L4 through L11 to obtain maximum reading on VTVM. Repeat to obtain true maximum reading.

C. **SIGNAL METER:** - Set signal generator to 146.000 +20dB output. Set VR6 so all LEDs are lit. Reduce signal to 0dB and confirm at least 1 LED is lit.

D. **DISCRIMINATOR:** - Set signal generator to 146.000, +10dB output modulated by 1KHz with deviation of ±3KHz. Connect VTVM to speaker terminals and adjust L11 for maximum.

E. **SCAN CENTER DETECTOR:** - Set dial to 146.000,

signal generator or signal source accurately to 145.998 (146.000 - 2KHz). Connect VTVM to pin 13 of IC6(TC-4011). Rotate VR7 from extreme C.W. slowly until VTVM suddenly drops from 4 to 0V. Leave VR7 set at this position. Vary transceiver dial by one click and confirm VTVM reading returns to 4 volts.

F. **CONFIRMATION OF SQUELCH SENSITIVITY:** - Set squelch just above threshold. Connect signal generator to antenna connector and confirm squelch opens with a -10dB signal.

G. **SINAD CHECK:** - Set signal generator to 146.000, +25dB, 1KHz modulation with 3KHz deviation. Connect distortion meter to speaker terminals. Set transceiver volume to obtain a 1V reading on distortion meter. Reduce signal to -6dB and confirm THD is less than 10%.

6.3 TRANSMITTER

A. Connect power meter, dummy load, frequency counter and spectrum analyzer to antenna connector.

B. **POWER AMPLIFIER:** - Set VR4 (Hi) of main unit fully clockwise disabling APC. Transmit (Hi) and adjust VC1 and VC2 to obtain maximum output with minimum spurs.

C. **MODULATOR:** - Connect audio generator to pin 1 of microphone connector, J4. Connect FM linear detector to antenna connector.

a. Set audio generator to 1KHz, 25mV. Transmit and adjust VR2 to obtain 15KHz deviation.

b. Set audio generator to 1KHz, 2.5mV output, transmit and set VR1 to obtain ±3.5KHz deviation.

D. **CALIBRATION OF HI/LOW POWER:** - Connect power meter and dummy load to antenna connector.

a. Set transceiver to LO. Transmit and adjust VR5 of main unit for 5 watts. (Do not set below 5).

b. Set to HI. Transmit and set VR4 for 25w.

NOTE: Always set LO before setting HI. HI should not be set above 25 watts.

E. **TRANSMIT LEVEL METER:** - Transmit with HI power and set VR1 on LED display PCB so all LED's light up. Next transmit with LO and confirm less than 4 LED's are lit.

F. **TONE MODULE ADJUSTMENT:**

a. Connect FM Linear detector to transceiver output and counter to output of linear detector.

b. **TONE-2033A** - Set TONE on and transmit. Set VR1 of tone PCB so counter reads 103.5Hz (or desired frequency.) Next set VR3 of Main Unit for deviation of about ±500Hz. Frequency can be varied approximately 78 - 220Hz with existing constants. A lower or higher frequency is possible by adding or reducing values of C1 and R2

c. **TONE-2033B** - This module provides a tone-burst of about 1 second at 1750Hz. Ground collector of Q2 in order to obtain continuous tone. Confirm frequency is 1750Hz. Adjust VR3 of Main Unit so deviation is about ±2.5KHz.

7.0 OTHER MISCELLANEOUS INFORMATION

7.1 MANUAL TONE OPERATION USING TONE-2033E

Where manual 1750Hz tone repeater accessing is needed make the following changes:

- Short circuit C4 (10mfd) of the tone module.
- Transfer tone switch PTT wire to next terminal.

7.2 CHANGING VFO TO "ENDLESS" OPERATION:

The VFO is programmed ex-factory to stop at the low and high band edges. To change to "endless" operation add diode D21(EDLS) in initialization module, INT-2033. As soon as the VFO dial is moved one click beyond the high or low limits VFO will jump to the other limit and continue increasing or decreasing operating frequency respectively.

7.3 MEMORY BACK-UP BATTERY:

All memories (and the VFO) are backed up using the internal NICAD battery with a charging circuit. When the transceiver is not used for extended periods it is recommended the battery be removed in order to prevent possible damage to the

printed circuit board.

A completely discharged battery can be recharged by leaving the transceiver connected to a power source and the power switched left "ON" for a few hours.

7.4 CIRCUIT DIAGRAM FOR TM-2 AND DM-100 MICROPHONES

Circuits are as shown below. The microphone connectors are shown as viewed from the front of the transceiver.

7.5 SCAN RESUME DELAY

An approximate 3 sec. delay has been built in to the SCAN resume of units supplied to some countries. This delay can be eliminated by removing the 2.2 mfd. electrolytic capacitor connected between pins 6 and 7 of IC6 of the CONTROL unit (C60).

Where this feature is not built in and is desired, connect a 2.2 mfd., 16 V, electrolytic capacitor between pins 6, (+), and 7, (-), of IC-6 of the CONTROL UNIT.

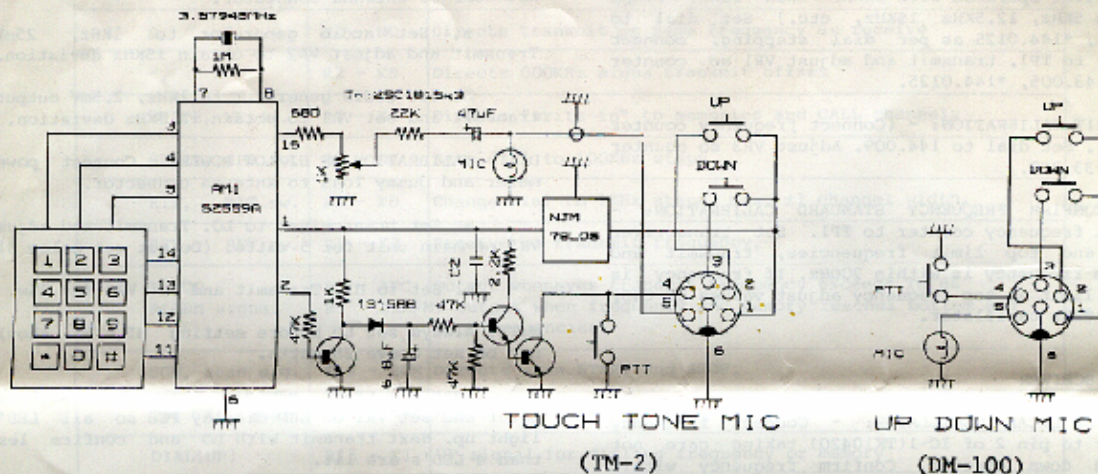

8. SPECIFICATIONS -- FM-2033

1. GENERAL

Semi-conductors:	FET-8, TR-12, IC-19 & DIODES-59
VFO steps spacing:	5KHz, *12.5, (100KHz, Speed switch on), "wrap-around"
Memories:	11 (A=1-5, B=6-10 plus "CALL")
Band scanning:	Programmable (Scans between memory 5 & 10)
Band scan steps:	Same as VFO steps
Memory scanning:	A+B=1-10, A=1-5, B=6-10, AXB=1-5
Type of emission:	F3
Antenna impedance:	50 ohms nominal, unbalanced feed
Supply voltage/current:	13.8 ±15%
Current consumption:	RCV: standby, .3A, max vol., .8A TX: 6.0A (25w), 2.5A (5w)
Operating temperature:	-10 - 60 deg. C.
Dimensions:	55h x 162w x 182d mm. (body only)
Weight:	1.7kg (body only), 2.4 (shipping weight)
Shipping dimensions:	100h x 210w x 320d mm.

2. TRANSMITTER

Frequency range:	142.005 - 148.995MHz (*144.0125 - 149.995MHz)
Output power:	25w (High) 5w (Low)
Modulation:	Variable reactance frequency modulation
Maximum deviation:	±5KHz
Spurious emissions:	Better than 60dB down
Repeater offset:	±600KHz
Repeater tone:	103.5Hz (adjustable), (E 1750Hz, crystal controlled)

3. RECEIVER

Frequency range:	142.000 - 148.995MHz (*144.000 - 149.995MHz)
Receiver type:	Double superheterodyne
IF:	First 10.7MHz, second 455KHz
Sensitivity:	S/N ratio better than 35dB, 1uV, SINAD better than 12dB with .2uV input
Squelch sensitivity:	Better than .150V
Bandwidth:	±5KHz/-6dB
Selectivity:	±12.5KHz/-60dB
Image ratio:	More than 70dB
Audio output:	More than 2w, 8 ohm load, THD 10%
RIT (Rec. incr. tune)	±1KHz steps, max one VFO step
Reverse:	Receive on transmit frequency

4. STANDARD ACCESSORIES INCLUDED

Microphone:	500 ohm, TM-2, tone encoder microphone with up/down buttons. (*DM-100 up/down microphone)
Power cable assembly:	1 piece, with 7A cartridge fuse
Spare fuse:	1 " 7A
External speaker plug:	1 " miniature phone plug type
Mounting bracket:	1 "
Screws, etc:	4 " 4 x 12mm self tapping screw
	4 " plain washer
	1 " microphone mounting clip
	1 " instruction manual
	1 " circuit diagram, folded

NOTE: A receiver spur will be encountered at 144.000MHz (Harmonic of 9MHz standard frequency.)

